

Part # **PLCC52**

Leads **52** Pitch **1.27mm (50mils)**

Body Size **19.1mm (.75" SQ)**

Dwg **PLCC52.pdf**

TopLineTM

Tel 1-714-898-3830

info@topline.to

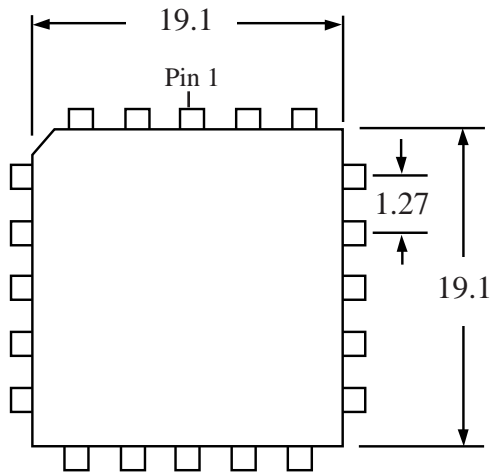

Top View

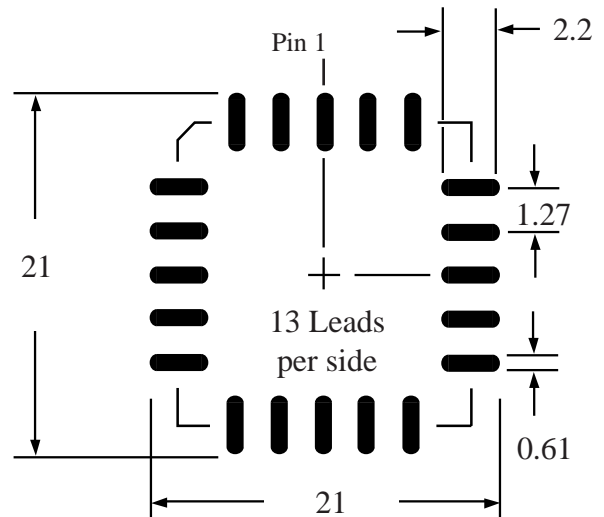

PC Board

Dimensions = mm

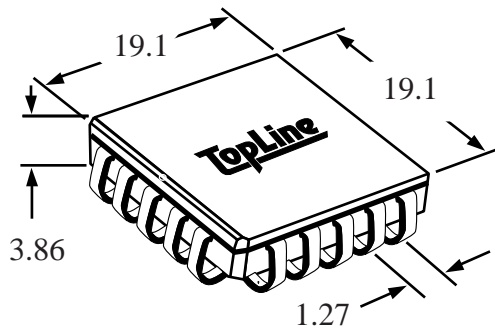

Quick View

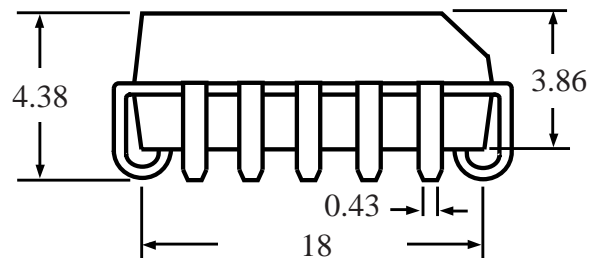

Side View Detail